



COVOL Series Volumetric Counters

- Volumetric counter for liquids.
- Precision $\pm 0.8\%$
- Construction in AISI-316, PVC, PP, PTFE
- DN 10 to DN 100
- Viscosity up to 120,000 mPa.s
- It can be easily cleaned and sterilized.
- It will work in any position.
- Mounting by means of steel PN-16 DIN standard flanges ASA flanges, NPT threads and sanitary connections on demand.
- High pressure versions available on demand.
- It can be mounted in hazardous areas (intrinsic security)
- Complete range of electronic equipment available for counting, analog outputs etc.
- It does not need straight sections of pipe.

Applications

- Filling containers.
- Batching and mixing.
- Vapour condensation and fuel consumption metering.
- Installation:
 - Counter and valves in the work area with protection according to the zone classification.
 - Counter in the safe area and valves in the hazardous area.
 - Full discharge pipe with air bleed or empty discharge pipe.



Principle of Operation

By means of an oscillating piston and an annular metering chamber.

The drawings show how the piston is moved by the liquid as it flows through the metering chamber.

The piston contains a magnet which acts on an exterior reed switch once for each complete cycle.

The electric pulses are the input for the control equipment (counters, indicators etc.)

Technical Data

- Pipe connections
 - Standard : DIN 2502 steel flanges for PN-16
 - On demand : ASA flanges, BSP threads, NPT, sanitary DIN 11851
- Precision $\pm 0.8 \%$
- Repeatability $\pm 0.3 \%$
- Measuring range 30 : 1
- Working temperature
 - AISI-316 -40 °C..... +150 °C
 - PTFE -20 °C..... +130 °C
 - PP -10 °C..... +80 °C
 - PVC 0 °C..... +45 °C
- Liquid Pressure
 - AISI-316 PN-16 (on demand up to PN-250)
 - PVC, PP, PTFE PN-10
- Reed Switch connector : IP-65
- Recommended Reed Switch cable : Shielded cable
- Reed Switch rating : 0.3 A 220 V
- EEx"d" housing on demand
- Body materials : AISI-316, PTFE, PP, PVC
- Piston materials : PTFE with Graphite, PTFE, Aluminium
- Heated or Refrigerated body on demand

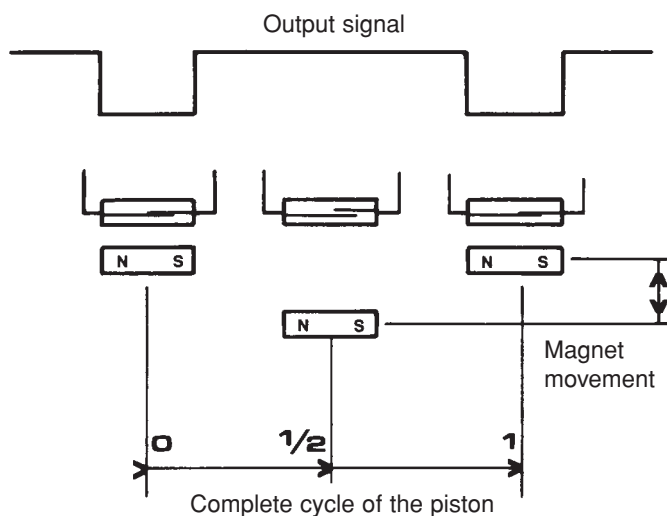

Operation

Position 1

The flow of a liquid through the COVOL volumetric counter exercises a pressure on the piston which starts the metering movement.

In this position the liquid is filling the inside of the piston.

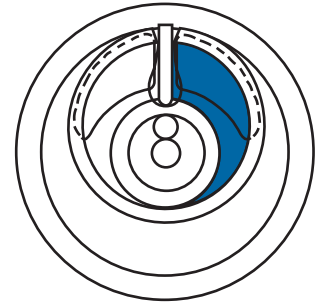

Position 2

The liquid starts to fill the cavity between the outside of the piston and the metering chamber, and continues to fill the inside of the piston.

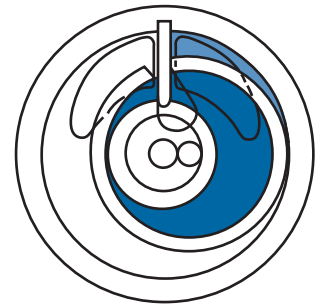

Position 3

At this point the inside of the piston is totally full, and the liquid continues to fill the outside cavity.

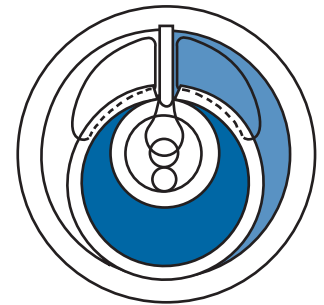

Position 4

The inside of the piston starts to empty through the outlet. The liquid starts to fill the inside of the piston for the next cycle and continues to fill the outside cavity.

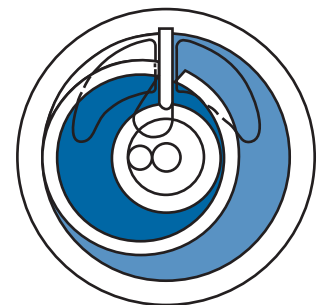

From this point the piston repeats the cycle, moving a **CONSTANT VOLUME** of liquid for each cycle.

Construction Detail

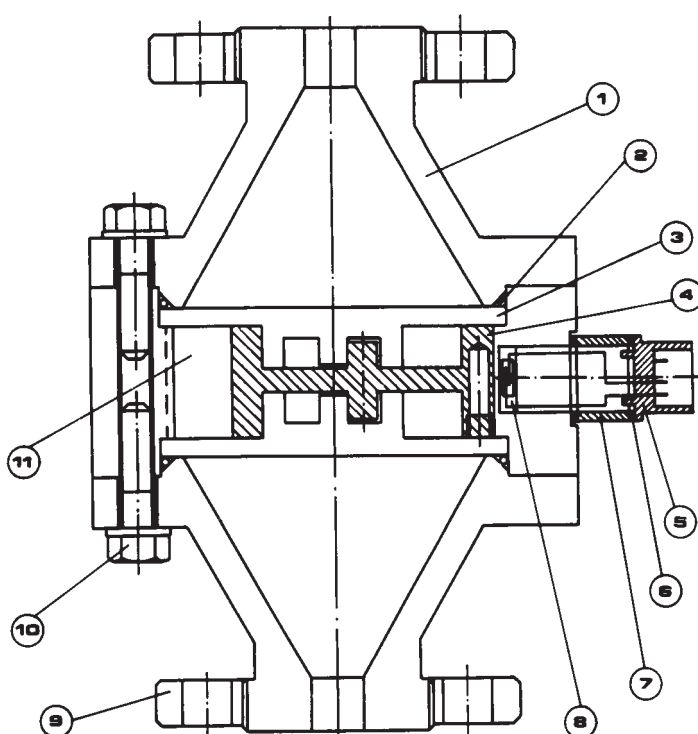

Mounting & Installation

It can be mounted in any position and does not need straight sections of pipe before or after the counter.

A FILTER MUST BE INSTALLED before the COVOL to guarantee correct working and avoid expensive damage. The mesh filter should have 0,1 to 0,2 mm² filter section, depending on the size of the COVOL. With small sizes the mesh should be finer.

In all processes where air or vapour can be present, an air separator should be installed before the counter to avoid errors.

Cavitation should not occur in the counter, and to avoid this we must follow the A.P.I. 2534 norm, which states that "at the outlet of counters the pressure should be higher than twice the pressure loss of the counter plus 1.25 times the vapour pressure of the liquid or its most volatile component".

Important: The installation of the cable between the COVOL and electronic equipment should not pass near mains or power cables in order to avoid picking up interferences which may influence the electronic counters.

Density and Viscosity

The COVOL volumetric counters are calibrated using water (density = 1 kg/l, viscosity = 1 mPa.s) and the pulses per litre are given in the calibration sheet.

N°	Part Name	Materials		
		AISI-316	PTFE	PVC/PP
1	Input/output chambers	AISI-316	PTFE	PVC/PP
2	Sealing ring	Nitrile Rubber/Viton_	Viton_/PTFE	Nitrile Rubber/Viton
3	End disc	AISI-316	PTFE	PVC/PP
4	Piston	PTFE-Graphite	PTFE-Graphite	PTFE-Graphite/PVC/PP
5	Reed Connector			
6	Sealing washer	Nitrile Rubber	Nitrile Rubber	Nitrile Rubber
7	Connector support	AISI-316	AISI-316/PTFE	AISI-316/PVC/PP
8	Reed switch	Glass	Glass	Glass
9	Flanges	Steel/AISI-316	Steel/PTFE	Steel/PVC/PP
10	Screws	AISI-316	AISI-316	AISI-316
11	Metering chamber	AISI-316	PTFE	PVC/PP

Flow rate graph

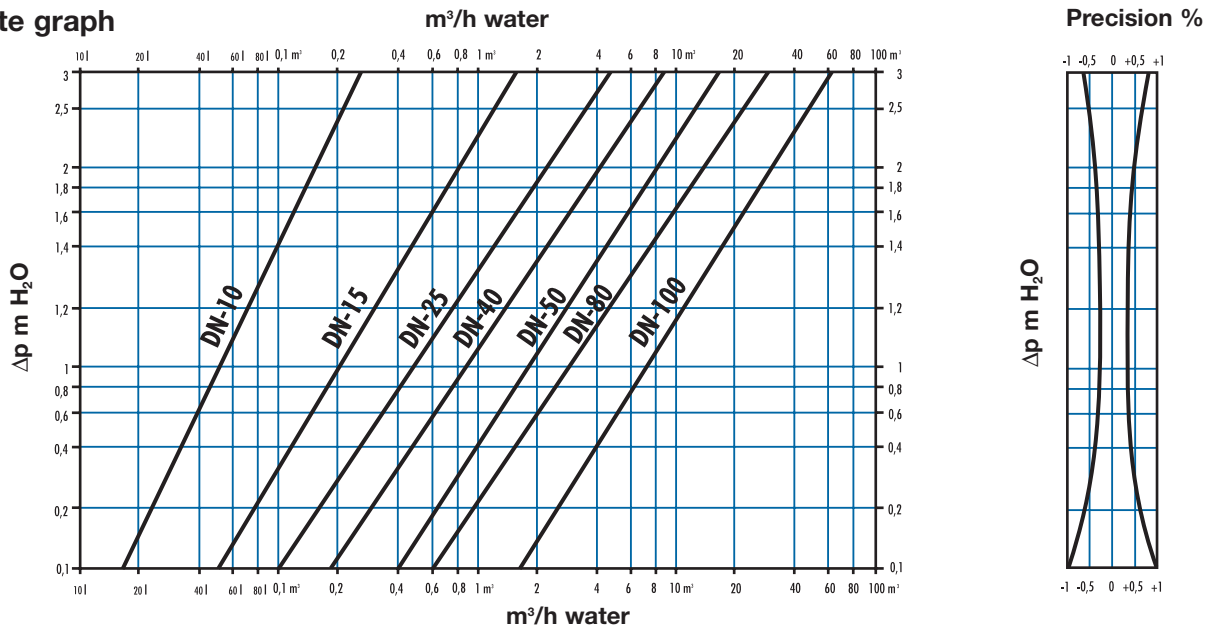

Variations of Δp m H₂O with viscosity

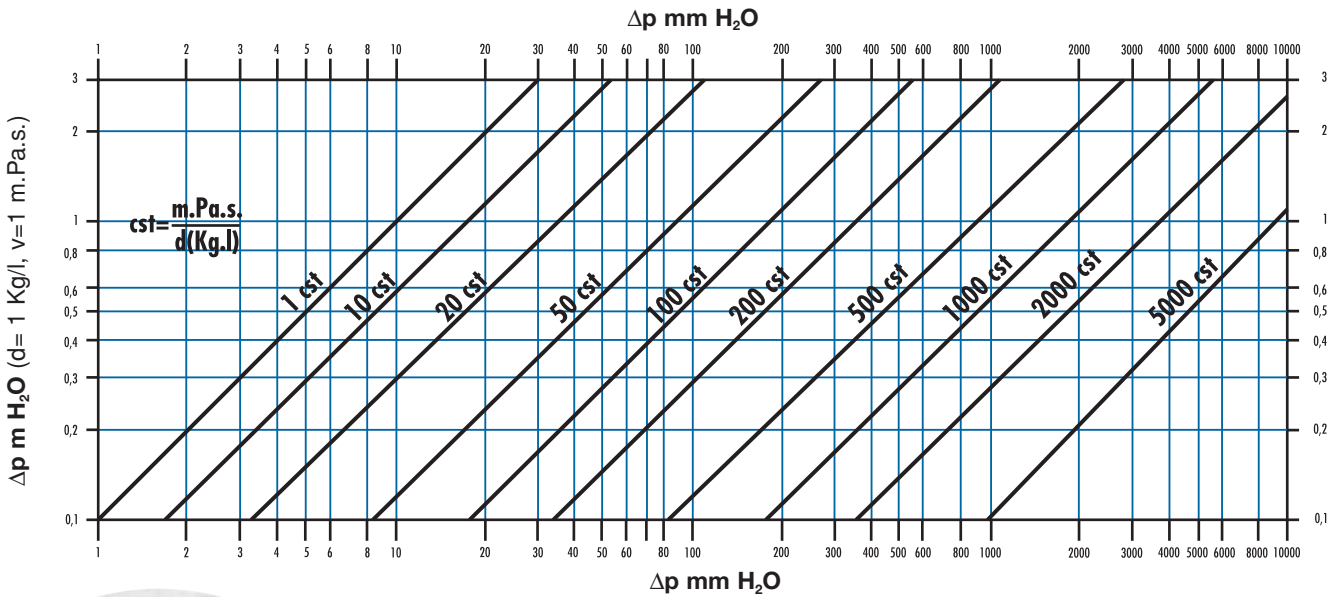

Variations of viscosity modify the pulses per litre factor of the counter but it does not affect the repeatability.

As a general norm, the variations of density only affect the COVOL counters at the beginning of the working range. When the density is less than 1 kg/l the flow rate must be higher to start to move the piston, and with the density greater than 1 kg/l the flow rate will be lower to start to move the piston.

In any case, the variations in density do not produce important changes in the calibration of the counter, these changes are not greater than 5-7% with respect to the values obtained with water.

Flow rates

DN	Min. l/h	Max. m ³ /h	Intermittent Max. m ³ /h
10	8	0,150	0,5
15 (special)	25	0,4	0,8
15	60	1,5	2,7
25	100	4,5	9
40	200	8,5	15,5
50	400	16	28
80	600	28	50
100	800	60	104

Pressure loss at Qmax for all models = 3 m H₂O

Pulses per litre factor

DN	Pulses/l ± 10%	cc/pulse ± 10%
10	100	10
15 (special)	50	20
15	20	50
25	10	100
40	4	250
50	2	500
80	1	1000
100	0,2	5000

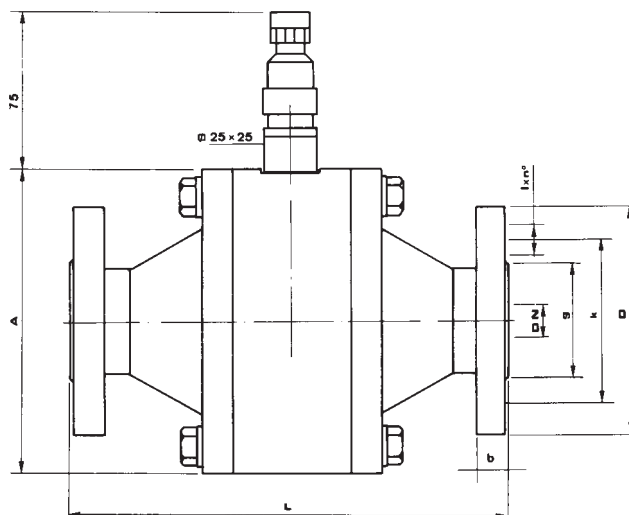
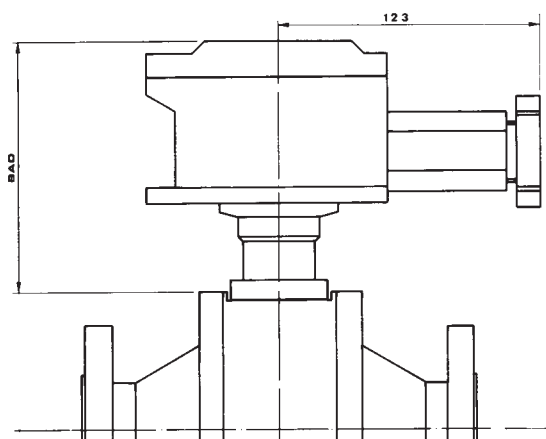

Dimensions and weight

DN	D	k	g	l x n°	b	L		A		BAD		Weight Kg	
						AISI-316	PVC/PTFE	AISI-316	PVC/PTFE	AISI-316	PVC	AISI-316	PVC/PTFE
10	90	60	40	14X4	14	180	210	85	125	176	196	6	5
15	95	65	45	14X4	14	180	210	105	140	187	204	9	8
25	115	85	68	14X4	16	200	230	140	170	204	219	10	9
40	150	110	88	18X4	16	220	250	180	200	224	234	18	15
50	165	125	102	18X4	18	240	270	200	230	234	249	26	21
80	200	160	138	18X8	20	260	330	250	290	259	279	37	30
100	220	180	158	18X8	20	340	450	360	420	314	344	92	80

Electronic Control Equipment

Standard Supply voltages : 240, 220, 110, 24 V AC 50-60 Hz
24 V DC

On order all the following electronic equipment can be supplied in EEx "d" II B T-5 enclosures.

MC-01 Series

- Micro-processor controlled instrument for flow control
- Fully programmable by user
- 2 lines of 16 characters (5 mm high) LCD Display
- 7 digit totalizing counter
- 7 digit partial counter with batching
- Relay output for batching
- Flow rate indication in l/h and m³/h

Options

- Analog output (4-20 mA, 0-20 mA 0-10 V etc.)
- LCD display with black light
- Inputs from Turbine, COVOL, 4-20 mA, etc
- Front panel cover with key
- Remote batching start push button

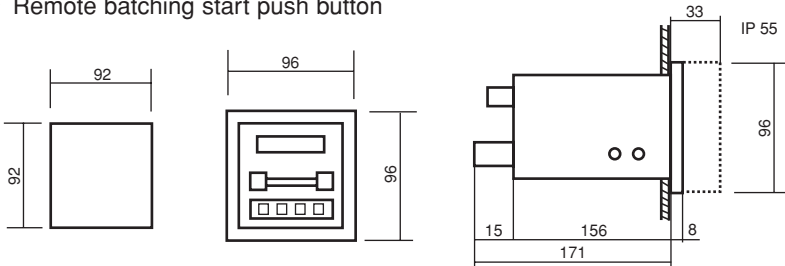

MT-02 Series

- Micro-processor controlled instrument for batching
- Fully programmable by user
- Bright LED display (7 digits for data and one digit for mode)
- 7 digit totalizing counter
- 7 digit partial counter with batching
- Relay output for batching
- Remote batching start push button

Options

- Inputs from Turbine, COVOL, TTL etc.
- Front panel cover with key
- 2 Relay version for precision batching

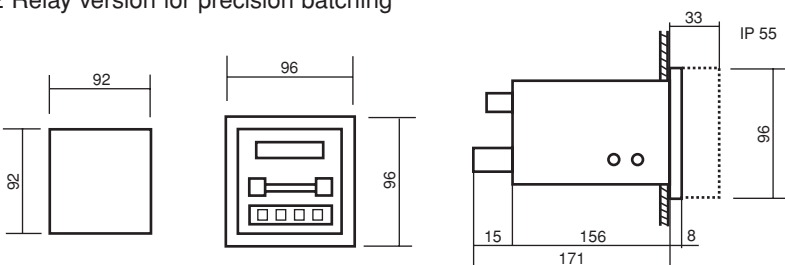

DFD Series Frequency Dividers

- Micro-processor controlled instrument for frequency division.
- Easily programable by user by means of BCD switches.
- Multiplies input pulses by the chosen factor.
- Factor range 0.9999 to 0.00000001
- Outputs : Open collector and TTL

Options

- Inputs from Turbine, COVOL, etc.



CI-420 Series Transmitter

- Micro-processor controlled instrument analog output.
- Easily programable by user by means of BCD switches
Just select frequency for maximum output.
- Input frequency range : 0.04 Hz..... 2,000 Hz
- Analog output 0-20 mA, 4-20 mA, 0-10 V, etc

Options

- Inputs from Turbine, COVOL, etc.

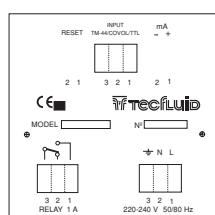
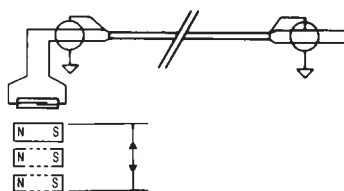

In order to avoid problems of electrical interferences which could affect the counters, the installation of signal cables should be done keeping them away from power and control cables.



Volumetric Counters

Filling reactors and tanks

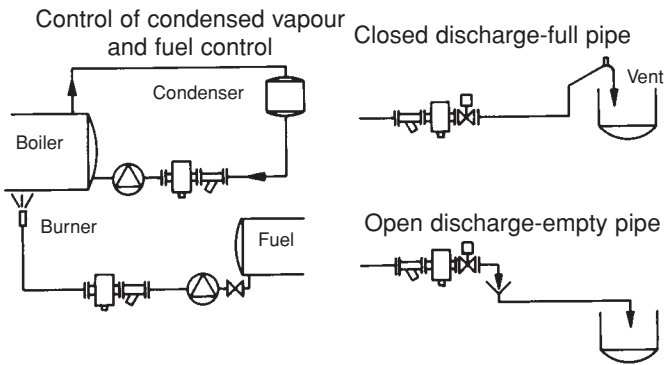
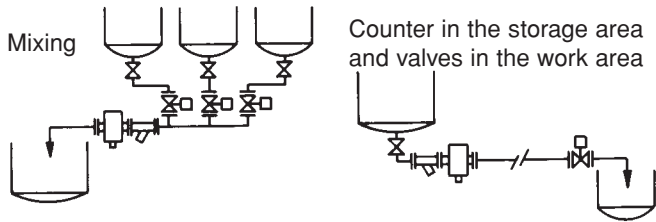
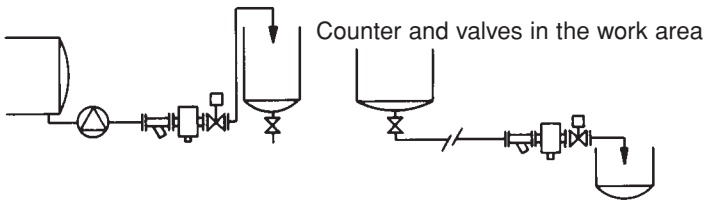

Liquids

Acetic acid	Glycerin
Acetone	Hidraulic oil
Acids	Hot water
Alcohol	Hydrochloric acid
Ammonium	Kerosene
Benzol	Paints
Benzene	Pentane
Butane	Petroleum
Caustic soda	Polymers
Colourings	Propane
Condensates	Organics products
Demineralized water	Nitric acid
Distilled water	Mineral oil
Distillate	Sea water
Ethyl	Sodium
Foods liquids	Solvents
Creams	Sulphuric acid
Syrups	Toluen
Juices	Water
Milk	
Vinegar	
Wine	
Foods oils	
Freon	
Gasoil	

Tecfluid designs and manufactures measuring instruments for liquids and gases, employing the most advanced technologies.

Flowmeters

- Tapered metering tube in Borosilicate glass
- Tapered metering tube in transparent plastic
- Variable area with metal metering tube and indication by magnetic transmission
- Target disc with indication by magnetic transmission
- Orifice plate with by-pass flowmeter
- Electromagnetic flowmeters
- Vortec

Levels

- Limit switches
- Level indicators
- Level transmitters with analog output (4-20 mA etc.)

We are at your service, please consult us.
 TECFLUID develops and manufactures instruments for gases and liquids, using the most advanced techniques.
 Request Information by telephone nº (34 3) 372 45 11

TECFLUID

C/. Narcis Monturiol, 33 - 08960 SANT JUST DESVERN (BARCELONA)
 International: Telephone. (34 3) 372 4511 - Fax (34 3) 473 08 54
 www.tecfluid.com - e-mail: tecfluid@tecfluid

The technical data in this pamphlet is subject to modification without notification, if the technical innovations in the product or manufacturing processes so require.